



Competition Rules 1999

FSR-H/V

Issued by the FSR Section of Naviga
in February 1999

NAVIGA

World Organisation for Model shipbuilding and Model ship sport
Weltorganisation für Schiffsmodellbau und Schiffsmodellsport
Organisation Mondaile de Navimodelisme et de Sport Nautique

NAVIGA

World Organisation for Model Ship Building and Model Ship Sport
Weltorganisation für Schiffsmodellbau und Schiffsmodellsport
Organisation Mondaile de Navimodelisme et de Sport Nautique



NAVIGA - Competition Rules 1999

Categories FSR - H/V

The NAVIGA - Competition rules of 1999 for the categories FSR-H and FSR-V have been updated based on the NAVIGA - 1997 Competition Rules, and the decisions during the General meeting in 1998

Amendments, additions and proposals for improvements are to be directed to the NAVIGA Section Management via the representative of the country.

In case of doubt of the interpretation of the Rules and Regulations the English text will prevail.

The NAVIGA Executive Committee

Editor's close for 1999: February 1999

<u>CONTENTS:</u>	<u>Page:</u>
1. DEFINITION OF MODELS.....	5
2. CLASSES.....	5
3. PRINCIPAL AND GENERAL RULES.....	6
3.1 PRINCIPAL RULES.....	6
3.1.1. Competitions where the rules apply.....	6
3.1.2. Entry fees.....	6
3.1.3. Protest fees.....	6
3.2 PERSONAL RULES.....	6
3.2.1. Age Groups.....	6
3.2.2. Competitors registration.....	7
3.2.3. Maximum allowed number of competitors.....	7
3.2.4. Assistant and substitution of the competitor....	7
3.3 TECHNICAL RULES.....	7
3.3.1 Propulsion of models and propulsion agents (fuel).....	7
3.3.2 Fuels	8
3.3.3 Noise reduction, noise level measurement and rules	8
3.3.4 Application and use of radio control equipment and frequency control.....	8
3.3.5 Time measuring.....	9
3.3.6 Buoys (dimensions, construction, anchorage).....	9
3.3.7 Starting pontoon (construction and materials).....	10
3.4 SPORT RULES.....	10
3.4.1. The competition area.....	10
3.4.2. Starting area, preparation area and access permission..	11
3.4.3. Allowed number, <i>entries and condition</i> of models.....	11
3.4.4. Re-run of a race.....	12
3.4.5. Registration numbers	12
3.4.6. Registration of competitors and models.....	13
3.4.7. Issuing of starting permits, issuing start and computer	13
3.4.8. Surrender of competitor passes <i>and assessment of running order</i>	14
3.4.9. <i>Calling time (time allowed to get ready)</i>	14
3.4.10. Preparation times (at the starting point).....	15
3.4.11. Interruption / Suspension of the competition	15
3.4.12. Scoring and announcement of the results.....	15
3.4.13. Checking of the first three placed models during World and Continental Championships.....	15
3.4.14. Awarding of titles at World and Continental Championships.....	16
3.4.15. Award ceremonies at World and Continental Championships.....	17
3.4.16. Result lists.....	17

3.5 NAVIGA PROTEST POLICY.....	17
3.5.1 Principal rules.....	17
3.5.2 Lodging of protests.....	18
3.5.3 Handling of protests.....	19
3.6 THE MODEL - MEASUREMENT CERTIFICATE.....	19
3.7 GENERAL RULES REGARDING CONSTRUCTION FOR FSR	19
	CATEGORY
4. GENERAL RULES REGARDING THE SET UP OF COMPETITION COURSES FOR FSR CATEGORY	20
5. GENERAL RULES REGARDING START AND TERMINATION OF A RACE OR HEAT.....	20
6. COMPETITION REQUIREMENTS IN FSR CATEGORY....	20
6.1 General rules and regulations.....	20
6.2 Manning level of the start pontoon.....	22
6.3 Minimum requirements for the starting area.....	23
6.4 Competition course and race duration in FSR-V classes.....	23
6.5 Procedure for races in the FSR-V classes.....	24
6.6 Lap counting for FSR-V races.....	27
6.6.1 Manual lap counting.....	27
6.6.2 Computerised lap counting.....	28
6.7 Scoring in FSR-V classes.....	28
6.8 Composition of result lists in the FSR-V classes.....	29
6.9 Competition course and race duration in the FSR-H classes.....	29
6.10 Start clock for FSR-H classes.....	30
6.11 Procedure for races in the FSR- H classes.....	31
6.12 Basic rules and penalties in the FSR - H classes.....	33
6.12.1 Left turns.....	33
6.12.2 Right of way.....	33
6.12.3 Negotiating / passing the buoys.....	33
6.13 Rules for overtaking in the FSR-H classes.....	34
6.14 Calculation of final results in FSR-H classes.....	36
6.15 Composition of result lists in the FSR-H classes.....	36
7. METHODS FOR MEASURING NOISE LEVELS IN THE FSR CATEGORY.....	37
7.1 General.....	37
7.2 Measuring methods in FSR-H.....	37
7.3 Measuring methods in FSR-V.....	37
 <u>APPENDIX</u>	
1. Guide to measuring and setting up a FSR-V course.....	38

Competition rules for radio controlled models in categories FSR – H and FSR-V

1. Definition of models

Models in the FSR categories are controlled by the competitor using radio control. These are model boats of free design, which conform to the race requirements, however should in form and design look like a boat.

2. Classes

The category FSR can be divided into the following groups and classes:

- | | |
|-----------------------|--|
| Class FSR-H3.5 | Free build HYDRO - planes* with internal combustion motor up to 3.5 cm ³ and below waterline propulsion. |
| Class FSR-H7.5 | Free build HYDRO - planes* with internal combustion motor above 3.5 cm ³ up to 7.5 cm ³ and below waterline propulsion. |
| Class FSR- H15 | Free build HYDRO - planes* with internal combustion motor above 7.5 cm ³ up to 15. cm ³ and below waterline propulsion. |
| Class FSR-V3.5 | Free build racing models for endurance races (20 – 30 min) with internal combustion motors up to 3.5 cm ³ and below waterline propulsion. |
| Class FSR-V7.5 | Free build racing models for endurance races (20 – 30 min) with internal combustion motors above 3.5 up to 7.5 cm ³ and below waterline propulsion. |
| Class FSR-V15 | Free build racing models for endurance races (20 – 30 min) with internal combustion motors above 7.5 up to 15.0 cm ³ and below waterline propulsion |
| Class FSR-V35 | Free build racing models for endurance races (20 – 30 min) with internal combustion motors (petrol-motor with spark plug ignition) above 15.0 up to 35.0 cm ³ and below waterline propulsion. |

Remark: * HYDRO-planes (A free build model with two or more planing surfaces).

3. Principal and General Rules

3.1 Principal Rules

3.1.1 Competitions where the rules apply

- (1) The NAVIGA rules apply to the following official NAVIGA competitions:
- World Championships
 - Continental Championships
 - International Competitions
 - International Friendly Competitions
- (1) For countries associated with NAVIGA it is recommended, that they use these rules in their national events.

3.1.2 Entry Fee

Entry fees for official NAVIGA events are as follows:

- for seniors 15.00 US Dollars per class
- for juniors 10.00 US Dollars per class

or the equivalent amount in local currency at the valid rate of exchange. There no additional fees for reserve model.

3.1.3 Protest Fees

The protest fee at all official NAVIGA competitions is 10.00 US Dollars or the equivalent amount in local currency at the valid rate of exchange.

3.2 Personal Rules

3.2.1 Age Groups

At NAVIGA events the competitors are divided into two Age Groups – Juniors and Seniors.

A Junior is someone who in the year of the competition is not older than 18 years.
(A Junior is someone who in the year of the event does not have their 19th birthday.)

3.2.2 Competitor registration

- (1) In order to compete in a championship or other international event an application must be made country's association on behalf of the competitor.

The application should be received by the Organisers in accordance with their terms and can be refused if received late.

- (2) An association is only allowed to enter competitors if their country's membership subscriptions, as set by NAVIGA, have been paid.
- (3) By entering the competition the competitor accepts the rules that apply.

3.2.3 Maximum Allowed Competitors

- (1) At the world championships each country is allowed to enter the following number of competitors in seniors and juniors:

- In the FSR-H classes 3 competitors and the title defendant
- In the FSR-V classes 3 competitors and the title defendant

- (1) In continental championships

- In the FSR-H classes each 5 competitors and the title defendant
- In the FSR-V classes each 5 competitors and the title defendant

3.2.4 Assistants and substitution of the competitor

- (1) In each class a competitor is allowed to have an assistant who will be designated by the competitor.
- (2) The assistant is allowed to help the competitor in the preparations for the start and until the finish of the race.
- (3) Substitution of the competitor is NOT allowed during the race.

3.3 Technical rules

3.3.1 Propulsion of models and fuels

- (1) Only internal combustion motors are allowed. Jet engines and other forms of non standardised propulsion are not allowed.

3.3.2 Fuel

- (1) Free fuel is allowed except in the FSR-V 35 class.
- (2) Fuel in the FSR-V 35 class must be a petrol-oil mixture.
Petrol can be of any octane level.
The use of Methanol mixtures is prohibited.

3.3.3 Noise reduction, noise level measurement and rules

- (1) Internal combustion engines must be equipped with a device to reduce noise levels.
- (2) *The equipment used to assess the noise level shall not exceed approx. 0.3 dB and must be in accordance with EEC and analogue rules. Noise level indicator issued by a recognised authority, must be readily available.*
- (3) *If for noise level measurements, self-registration equipment is used, these should reflect the measurements of the noise level indicator without too many differences. It is therefore recommended that a comparison between the equipment in use should take place. The comparison has to be checked by the Jury or the Organisers at the start of the event/race and maintained throughout.*
- (4) Noise level readings should be taken by individuals who have been trained appropriately and have practical experience.
- (5) The noise meter should be set on “SLOW”.
- (6) For the method of measuring noise levels in classes FSR-H and FSR-V refer to paragraph 7.

3.3.4 Application and use of radio control equipment and frequency control

- (1) During official NAVIGA events only digital and proportional operated radio control equipment is allowed. The radio control must be capable of working within 20 kHz, which for example, would allow 12 models in the 27 MHz band. The use of any other frequency bands may be possible.
- (2) It must be possible to change frequency at short notice. Each competitor must have four different pairs of crystals.

- (3) The use of the radio control equipment is subject to the regulations of the country where the NAVIGA event is held. Organisers must list the available frequencies in the entry form for the event.
- (4) It is recommended that frequency checks are carried out to avoid frequency clashes. At world and continental championships there must be frequency checks.
- (5) The re-run of a race due to radio problems can be refused by the race officials, if the planned finishing time of a race or championships is seriously endangered.
- (6) The team leaders will be the only ones informed of the frequencies allocated to the competitors. The frequencies will not be published in the start list.
- (7) The frequencies must be recorded in mHz only.

3.3.5 Time Measuring

- (1) Time should be measured to a tenth of a second. If timers are used with greater accuracy, the second decimal digit should be ignored.
- (2) Electronic or manual timing can be used. Electronic timing means the time is automatically measured by electronic or electromagnetic timing systems. The timing assessed by manually operated electronic timers, is not classed as electronic timing.
- (3) The start official must before the start of the race, test that timers and clocks are working correctly.
- (4) Times shown on the timers or clocks can only be released, when the start official has ensured that the proper reading has been entered in the results list. The release of the time is done by the start official.

3.3.6 Buoys (Dimensions, Construction, Anchorage)

- (1) The race course has to be marked by buoys. Each buoy must consist of two colours and have good visible coloured stripes which must be at a right angle to the water surface.
- (2) The buoys must be cylindrical and a minimum of 200 mm and maximum 500 mm above the water surface. The buoys have to be anchored so that they are at a right angle to the water surface.
- (3) The buoys must be 400 to 500 mm in diameter.
- (4) The buoys must be made of materials such as polystyrene, cork, natural fibres, etc.

3.3.7 Starting pontoon (Construction and Materials)

- (1) Starting pontoons have to provide adequate space for the competitors, their models, assistants and judges. Any obstructions which could endanger the safety of the competitors and models should be avoided.
- (2) The starting pontoon must be a minimum of 13 x 1,5 m wide and 19,5 meters long. (see appendix 1)
- (3) Access to the starting pontoon should be clear. The surface of the pontoon must be non slip even when wet.
- (4) The starting pontoon should when occupied not move, roll or in any other way change position. The surface of the starting pontoon must not be higher than 150 mm above the water surface.
- (5) Floating starting pontoons are only allowed when the anchoring and stability are sufficient to prevent rolling caused by waves or movement of people.

3.4 Sport Rules

3.4.1 The Competition Area

- (1) The competition site especially the racing water and the surrounding area should be selected by the organisers to give competitors the best possible conditions to achieve good results.

The organisers must ensure that adequate safety measures are in place to protect competitors, officials and spectators from possible dangers.

- (2) The competition site, the racing water and the surrounding area must be checked prior to the race by the race officials. In the event of complaints the organisers must attempt to correct this immediately.
- (3) The competition site and the race water must not be contaminated by mineral oils, grease and other poisonous substances.

Failure to comply with this rule will result in disqualification of the competitor, who will not be able to lodge a protest.

3.4.2 Starting area, the preparation area and access permission

- (1) The starting area is the enclosed area directly adjacent to the racing water, in which the starting pontoon is located from which the competitors launched their model.
- (2) The preparation area is an enclosed area, where all competitors prepare the models and equipment for the start and serves as a waiting area during the event.

The preparation area should be located as close as possible to the starting area, subject to local facilities. It should provide accommodation and protection from weather conditions for the models. Only officials, competitors and assistants engaged in the event are allowed in the preparation area.

- (3) Only race officials, competitors and their assistants are allowed on the starting pontoon.

The minimum requirements for the starting area are specified in section (6.3)

- (4) On the starting pontoon it is prohibited to use umbrellas during a race.
- (5) It is prohibited, to run engines within 200 meters around the starting pontoon during the race.

3.4.3 Allowed Number, *Entry Possibilities and Race Conditions* of the Models

- (1) In the category FSR each competitor can register for the event two models per class.
- (2) It is the choice of the competitor which of the two models he will use for a race. Both models can be brought into the preparation area. However, only one model can be taken on the starting pontoon. After the start of the preparation time it is not possible to change models. In the event of a breakdown during a race it is not allowed to use the second model. It may only be used during the competitors next race.
- (3) *For entry of a model in other classes the following rules apply:*
 - *A model in classes FSR V3.5, FSR V7.5, and FSR V15 can also start in classes F1-V or visa versa provided it complies with the building rules of subject class.*
- (4) *The entry of a model in other classes has to be announced at the time of registration.*

- (5) *Each model must from start to finish of the event show the condition in which it has been originally registered. If during the start a part is missing or such a part has been added i.e. this part was lost during the race, this start will be without time i.e. without a score registered. The decision rest with start official.*

3.4.4 Re-run of a race

- (1) There is no right to a re-run if a model is damaged during a race or if a propeller is caught by a foreign object like weeds etc.
- (2) A race can be repeated, when the timing or the lap counting fails.

3.4.5 Registration Numbers

- (1) At all NAVIGA events all models must have fixed registration numbers.
- (2) The registration numbers are given out by the respective country. If the nationality is not part of the registration number it must be attached to the models. Registration numbers and nationality must not be changed and must be permanently fixed.
- (3) The race and spare model must show an identical registration numbers.

Boat– upper deck XYZ = Nationality
 H3 = National Registration Number

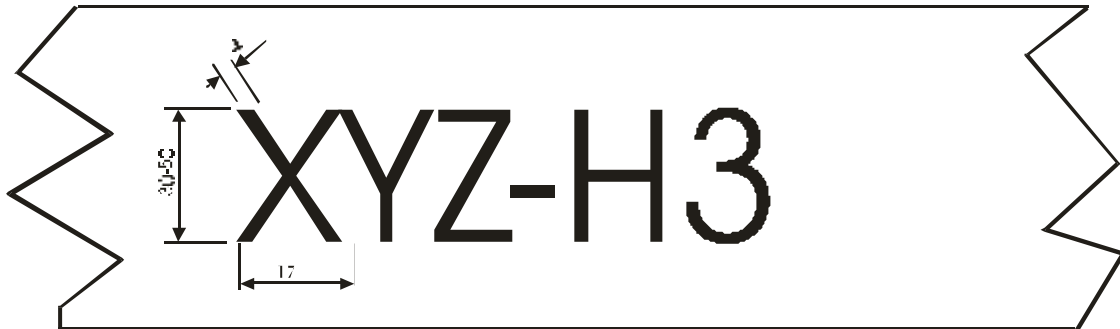

Drawing 1 Registration number

3.4.6 Registration of competitors and models

- (1) Each competitor is required to register their models including any spare models and their radio control equipment, within the registration time announced.
- (2) Together with the models, the competitor must show the confirmation of their registration issued by the organisers. Group confirmation should be shown by the team leader.
- (3) Qualified judges should be appointed by the organisers to carry out registration. These have to be confirmed by the jury of race officials.
- (4) The registration must be arranged by the organisers so that it can be completed within the set period, ensuring the planned start of the race and minimum disruption to competitors. According to the number of registered competitors and models, marked registration areas for various classes should be arranged.

The organisers must appoint sufficient qualified assistants.

- (5) The competitors must show their model for registration in the condition, in which it will be used in the race.
- (6) The following items must be included in the registration list:
 - Surname, Christian name of the competitor and their nationality
 - Class
 - Registration number
 - Specification of the radio equipment (frequency, modulation, working frequency, spare crystals)
- (7) A marking on an appropriate place on the hull (shield, sticker, stamp or similar) must be affixed to each registered model.

The marking should not leave permanent stains on the outside of the model.

3.4.7 Issuing of starting permits, issuing start and competitor passes

- (1) After registration, the chief judge (at World – and Continental Championships the jury) must announce the *start permission*.

This must be done by public announcement giving the names of competitors and classes entered. Reasons for refusal must be given.

(2) The competition or the championship can only start one hour after the announcement of the starting permits.

(1) The competitor passes are to be issued by the organiser on the basis of the entries and should be handed to the competitor at the time of registration.

The competitor must ensure that the entries on the competitor pass are correct. The organisers must be notified of any changes.

(4) *The Organiser i.e. the Duty Officer must issue the starting permits and to ensure that these are readily available at the starting point.*

3.4.8 Surrender of competitor passes and Assessment of Running Order

(1) Prior to the race the competitor must hand in the starting permit to the start official, failing which the competitor loses their permission to start that race.

(2) *The start sequence of the competitors at a starting point must be assessed prior to first the race or lap per class under jurisdiction of the start position leader or otherwise appoint the available crystals*

In the event additional races take place, the starting sequence must be reversed.

(3) *In the event of two or more starting point are available, the competition leaders or jury can decide which frequencies are to be used at a certain starting point.*

(4) *If the competitor in the same event, competes in various model classes, of which the races take place at the same time at a different starting point, there is no possibility (right) to request a change of the starting time and/or a change of starting sequence.*

3.4.9 Calling time (Time Allowed to Get Ready)

(1) *The calling time is one minute. Within this time the start leader must call the competitor three times by name to show at the starting point.*

(2) *If the competitor does not show up with his/her model within the calling time, the competitor loses his/her right to start for this race or lap.*

(3) *At the call of the competitor to the start, the next competitor should be announced to prepare for the start in accordance with the start sequence.*

(4) *In the event a competitor does not show up to start, the calling time for the next competitor in the starting sequence amounts two minutes.*

3.4.10 Preparation times (at the Starting Point)

- (1) *the preparation times commence when the competitor shows up with his/her model at the starting point and when entering the starting place. The commencement of the preparation time will be decided by the start position official and must be mentioned to the competitor.*
- (2) *The finish of the preparation time must be announced verbally and possibly also optical. This should be done at full minutes intervals.*

3.4.11 Interruption / suspensions of the competition (re 6.5.20)

- (1) An interruption of the complete event can only be announced by the chief judge.
- (2) An interruption of the competition at a starting pontoon is decided by the start position official.
- (3) If a competition is suspended in excess of 60 minutes, the complete race has to be re-run *for all competitors.*

3.4.12 Scoring and Announcement of the Results

- (1) All results of a competition should immediately be announced or displayed at the starting area. The verbal announcement must be made in at least one of the three official NAVIGA languages in addition to the national language. The verbal announcement is regarded as a provisional result.
- (2) The results are to be recorded in the result list. After the completion of the event the results must be checked and made public within two hours. This is a preliminary result list.
- (3) The jury can confirm the final results one hour after issuing the preliminary results.
- (4) After confirmation of the results by the competition officials i.e. jury, it is no longer possible to protest against the results.
- (5) Competitors with a zero result will be recorded at the end of the result list in alphabetical order.

3.4.13 Checking of the first three placed models during World and Continental Championships

- (1) At World and Continental Championships the first three placed models must be checked that they conform to the construction regulations and the engines are measured for their true capacity.

- (2) In the FSR-V classes, with exception of the FSR-V35 class, preliminary checks after the heats can be done to assess the exact capacity of the engines.
- (3) *In the FSR-V35 class the measurement of the cylinder capacity of the first three placed models is done on the basis of the construction particulars after the completion of the finals.*
- (4) With internal combustion engines the measurement of the capacity must be done when the engine is cold. A tolerance of + 1% is allowed.
- (5) Cylinder capacity measurements are done as follows:
 - The measurement of the cylinder is done with a depth indicator through the glow / spark plug hole. Only after this, the engine will be opened.
 - The measurement of the bore is done with an inside measurement indicator in the region between the upper level of the exhaust opening and the top dead centre. Two measurements must be taken (approx. 90 degrees opposite each other) and the results averaged.
 - Calibrators for the measurement instruments must be kept at the competition site.
 - The checking of the capacity measurements is done from tables or computer print outs.
 - During the qualification heats in the FSR-classes the start leader can select three models for capacity checks. The measurement will be taken after the heat when the engines have cooled down. Exceeding the allowed capacity means disqualification from that heat. After completion of finals the models placed 1 to 6 will be put aside. If not cylinder capacity discrepancies are found for the first three placed models, further checks are not necessary.
- (6) The competitors must make their model available to the appointed judge. The competitors have to open the engine, failure to do so will result in disqualification
- (7) In the event that the measurement results are not in accordance with the regulations, the respective model will be disqualified. In that case the placing of the following models will improve and they will have to be inspected.

3.4.14 Awarding of titles at World and Continental Championships

- (1) For juniors the World Championship title will be awarded, if a minimum of 6 competitors from 3 different countries have raced in the respective class.
- (2) For seniors the World Championships title will be awarded, if a minimum of 10 competitors from 5 different countries have raced in the respective class.

- (3) In case a World Championship for a certain class is held with less competitors than described in paragraph (1) and (2), no titles and medals will be awarded in those classes. The achievements of the competitors will be acknowledged by special certificates.

3.4.15 Award Ceremonies at World and Continental Championships

- (1) At World Championships the first three placed competitors in each class of juniors and seniors receive a gold, silver or bronze medal and a certificate, which are provided by NAVIGA.

At Continental Championships the first three placed competitors in each class of juniors and seniors receive a gold, silver or bronze medal and a certificate.

- (2) In addition to the first three places at World Championships each competitor receives a Certificate of attendance.
- (3) In addition to the title, medals and certificates, an honorary award can be given for special achievements.
- (4) The title, medals, certificates and honorary awards must be presented in a public ceremony.
- (5) All competitors and officials must attend the prize giving ceremony. A competitor who without a founded excuse does not attend the ceremony, loses the right to title, medals, certificates and honorary award. The decision in respect of excuses rests with the competition officials i.e. the jury.

3.4.16 Result lists

The organiser of a NAVIGA event must, after the completion of the event (ceremony), give at least 3 complete result lists to each of the participating countries.

For special regulations regarding the contents of the result list refer to sections 6.8. for FSR-V and 6.15 for FSR-H.

3.5 NAVIGA – Protest Policy

3.5.1 Principal Rules

- (1) A protest can only be lodged, if a competitor is convinced that their race result has been affected by a decision, act or omission made by the members of the competition management, the jury, judges, the organiser or by unfair acts of other competitors or teams.

- (2) *Protests against the timing and/or combined protests are excluded.*
- (3) The final results, placing, the awarding of titles, medals and honorary awards can only take place after all lodged protests have been resolved.
- (4) The decision of the jury is final. Appeals are not accepted.

3.5.2 Lodging of protests

- (1) *Each protest must be verbally reported to the starting official immediately upon observation of the alleged discrepancy. Within one hour after completion of the race in which the incident occurred, the protest must be lodged in writing to the competition management e.g. the Jury in one of the three official NAVIGA languages.*
- (2) The lodging of a protest does not exclude the competitor from further participation in the competition. If the competitor withdraws from further competition on grounds of a lodged protest, they will be disqualified from the whole event. In this case their lodged protest will be rejected.
- (3) If after a verbally lodged protest measures are being taken to correct the situation a written protest will not be necessary. The competitor must be advised prior to the acceptance of the written protest and the protest fee.
- (4) The written protest must contain the following:
 - Grounds of the protest (respective rules, regulations, acts and where to find them)
 - Time, place including a precise description of the incident, the reason for the protest, possibly including drawings and other evidence.
 - Statements and names of witnesses, who have been involved in the incident and are willing to truthfully answer questions regarding the protest.
 - Statement, with which start official and at what time, the protest was verbally lodged.
- (5) The protest must be signed by the competitor and the team leader of the respective country.
- (6) The protest fee must be paid when the written protest is lodged, or the protest will be null and void.

3.5.3 Handling of Protest

- (1) The jury has to consider an officially lodged protest, for which the protest fee has been paid and give a decision. During the protest negotiations the team leader of the country whose competitor lodged a protest has no voting rights.
- (2) If during a protest a competitor is accused to have breached the rules, the jury has to carry out the protest procedure against the accused competitor.
- (3) The competitor who has lodged the protest and the person against whom the protest negotiations are conducted, have the right to attend the hearing without voting rights. For the protest negotiations the jury can call further witnesses involved in the incident who must give a truthful account.
- (4) The decision given by the competition management on the outcome of the protest must be announced to the competitors by means of a public notice in one of the three official NAVIGA languages
- (5) If the protest is successful the protest fee has to be returned to the competitor. If the protest fails, the protest fee will remain with the organiser.

3.6 The Model – Measurement Certificate

For model classes FSR-H and FSR-V no international model – measurement certificate is required.

3.7 General rules regarding construction for category FSR

- (1) For competitions in category FSR models are of free design. The model however must be owned by the competitor.
- (2) The overall length of the model in the FSR category, must not exceed 2500 mm.
- (3) The steering of the model must be through radio control.
- (4) One or more internal combustion engines can be used. However their total cylinder capacity must not exceed the respective class.

4. General Rules regarding the set up of competition courses for the category FSR

- (1) The competitions in the category FSR are performed on two different courses.
 - For the FSR-H category see drawing 4
 - For the FSR-V category see drawing 3
- (2) The competition courses are to be placed in calm, preferably sheltered from wind, waters.

5. General Rules regarding start and termination of a race or heat

- (1) During the competition the competitor is free to move within the clearly marked area allocated by the organizer on the starting pontoon.
- (2) After completion of the race or heat the model must be taken out of the water immediately and radio control switched off.

6. Competition requirements in FSR category

6.1 General construction rules and regulations

- (1) *The hull has no construction rules, however it must in form and shape look like a Mono hull.*
- (2) The engine must have full throttle control. The size of the tank is not restricted. *Fuel has to be supplied by the competitor.*
- (3) Every model must have on the deck a longitudinal mount for attaching number plate which has to be provided by the competitor. The number plate must be made out of flexible and durable material, which does not cause damage to the model when run over. The plate must be white and the numbers from 1 to 13 must be black. The number plate must be attached to the model with two connections.
- (4) The dimensions of number plates for classes FSR-V and FSR-H are as follows (see drawing 2):

-	Height	100 mm	
-	Width	120 mm	<u>The corners of the shield must be rounded off</u>
-	Thickness	approx. 2 mm	
-	Distance between the holes	100 mm	
-	Distance of hole from the bottom of plate	10 mm	
-	Diameter of hole	5 mm	

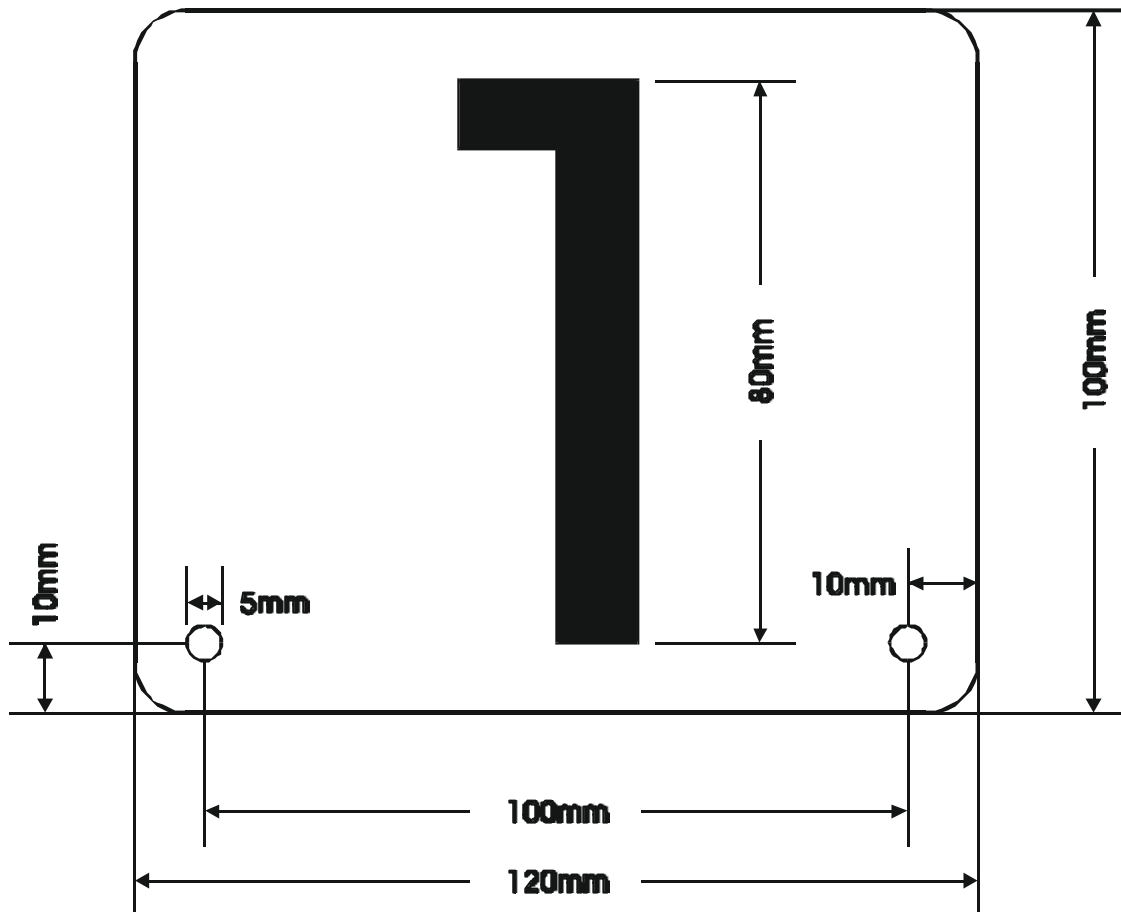

Drawing 2: Number plate for classes FSR-H and FSR-V.

- (1) 5. The organiser has to provide two powered rescue boats, which have to be stationed on the left and right hand side of the starting pontoon. The crews for the rescue boats have to be provided by the organiser. *It is recommended to the organiser that of the two rescue boats one is equipped with a motor. The second can be a rowing boat. A rowing boat must have the oars fixed to the boat. The oars must have a device which prevents the oars to be rejected.*
- (2) 6. Inflatable boats, and other boats which could be damaged on impact and endanger life of the crew, must not be used as rescue boats. The crew of the rescue boats must wear life jackets. *If the protective suites are not life belts, the rescue boats must be equipped with life buoys.* To improve the safety of the rescue boats these should be equipped with safety boards, which should be mounted on the outside to prevent damage.
- (3) 7. The rescue service is controlled by a start position official. The models must be rescued in the shortest possible time, causing minimum disturbance to the models still racing ensuring that all the competitors are treated fairly. Powered rescue boats must be used slowly, so that the bow waves have no adverse influence on the race. The continuous circling of rescue boats within the course should be avoided. *Powered rescue boats should preferably be used to rescue those models which are farthest from the starting jetty.*
- (4) 8. In classes FSR-H the rescue of models is only performed after completion of the heat.

- (5) 9. During the race nobody is allowed in the racing water. Competitors not obeying this rule will be disqualified.

- (6) 10. The starting pontoon has to be divided into approximately 1.5 meter sections for each competitor. The starting positions must be numbered and allocated prior to the race. FSR – starting pontoons must have a board in front to prevent boats landing on the pontoon.
- (7) 11. At world and Continental Championships of the FSR group, the organiser must provide a 1 meter high platform as part of the starting pontoon for the competitors to drive from.

The raised platform must also be numbered with starting positions. The competitor is left the choice from which level they wish to drive. The competitor and assistant can only use the allocated starting position.

- (8) 12. Safety nets or other safety devices must be positioned around the competition site to avoid endangering spectators. This should take into consideration models that might collide or come off course.
- (9) 13. FSR -V 35 boats must have a towing eye on the front for rescue purposes.
- (10) 14. For safety reasons the competitors in the FSR-H/V15 junior and FSR-V35 junior classes must be at least 12 years old.
- (11) 15. In order to ensure a quick rescue, all FSR-V boats must have a proper lifting point.

6.2 Manning Level of the Start Pontoon

The manning level of the start positions in the FSR group is as follows:

- 1 chief pontoon judge
- 2 assistant pontoon judges (to support the chief pontoon judge and observe the race)
- 1 official measuring the noise levels
- 1 secretary
- 4 Judges for lap counting

6.3 Minimum requirements for the starting area

The minimum requirements for a starting area in the FSR category are:

- A starting pontoon for FSR-V class should be minimum 19,5 meters long and 1.5 meters wide, with numbered starting positions from 13 – 1. In the FSR-H class the starting pontoon should be minimum 12 meters long and 1.5 meters wide, with numbered starting positions from 8 – 1.
- 2 rescue boats in accordance with paragraph 6.1 item (5) and (6).
- 1 noise meter
- Tables and chairs for the judges possibly protected from the weather.
- Tables and chairs for the lap counters possible protected from the weather.
- 3 Yellow cards one plain, one with the number 1, one with the number 2.
- 1 red card.
- 1 signal device to indicate the start/finish of the heat.
- 1 clock to indicate the racing time.
- 1 public address system.
- 2 sets of number plates with the numbers 1 to 13 for FSR-V and 1 to 8 for FSR-H.
- *1 board with the drawing of the respective FSR-course*

6.4 Competition course and duration of the race in the FSR-V Classes

- (1) The competition will be held on a course as shown in drawing 3. The competition course has to be placed so that the base line runs parallel to the starting pontoon and the centre line is at a right angle from between start positions 6 and 7 to the centre buoy.
- (2) A competition consists of two 20 minute heats and a 30 minute final. After the first 10 minutes and every following 5 minutes there must be a verbal announcement of the time elapsed. The time elapsed must also be displayed to the competitors.

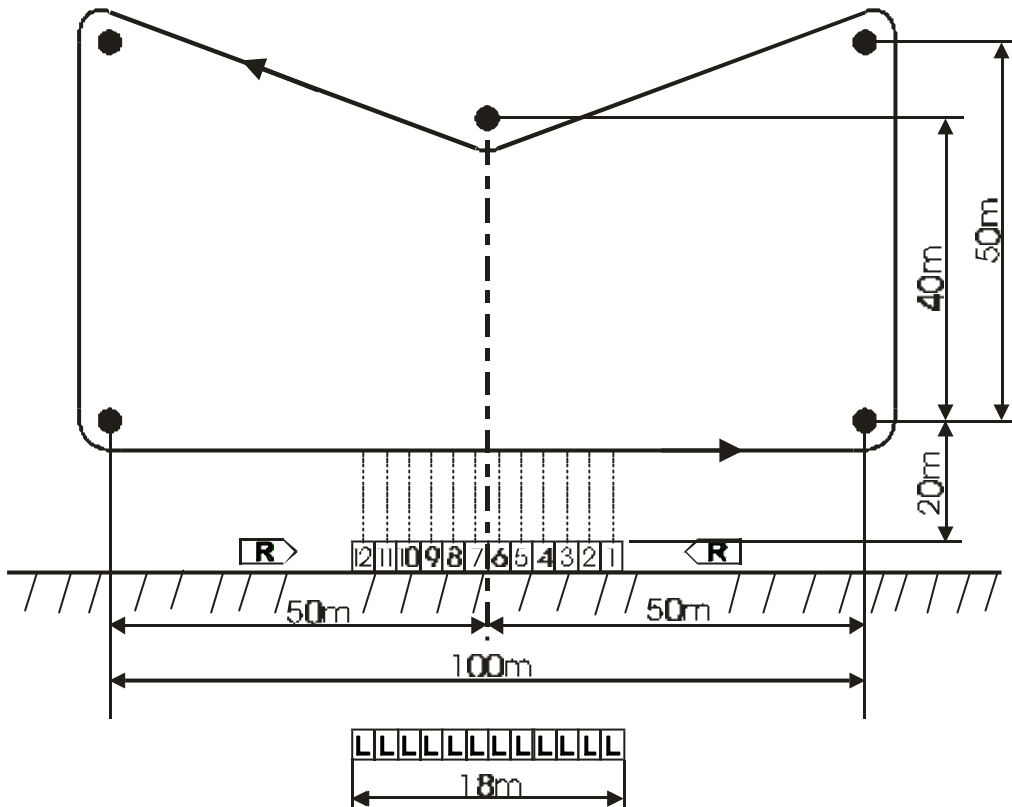

- = Start and finish line
- 13 - - 1 = Start positions
- RB = Rescue Boat
- LC = Lap counters

Drawing 3: FSR -V competition course

6.5 Procedures for Races in the FSR-V Classes

- (1) The course is sailed anti-clockwise. For every heat maximum of 12 and minimum of 3 competitors are allowed. If more than 12 competitors have entered the competition, they should be split into equal groups of no more than 12. The make up of the groups should be random, taking into consideration the available crystals. This will be checked by the judges. For the first heat the start positions are allocated by the organiser. For the second heat the start positions are reversed (the start numbers are the same as in the first heat).
- (2) All heats in an individual class should be run consecutively with the aim that the same weather conditions apply to all competitors.

- (3) When more than 12 competitors enter a championship a qualification races must be held in order to decide the 12 finalists. If competitors in 12th and 13th place have equal laps and time the final will be run with 13 competitors. If competitors in 12th 13th and 14th place have equal laps and time the run off has to be held to decide the 12th place finalist. *If after this the competitors are still on equal laps – and heat times, a raffle has to be held.* The start positions for the finalists will be decided in sequential order using the best results of the qualification heats. The competitor with the highest number of laps in the qualification heats will occupy start positions 1, the start position 12 / 13 is allocated to the competitor with the least number of laps in the qualification heats. In case of equal number of laps the position will be decided by the shortest delay time on the last lap.
- (4) Before the start of each race a radio check has to be carried out to prevent interference. Therefore all transmitters and receivers must be switched on. When it has been confirmed that there is no radio interference it is no longer possible to protest.
- (5) After the radio check, the preparation time begins.
- (6) The preparation time for the FSR-V classes is 4 minutes. During this time the competitor is allowed 3.5 minutes to warm up and tune the engines. During this time the model can be place in the water but must not be released.
- (7) 30 seconds prior to the start all models must be on the pontoon with the engines switched off. During the remaining time the competitors and assistants are not permitted to attend to their model. The start position official can start the race within those 30 seconds.
- (8) The race will begin with an acoustic signal given by the start position official. After the signal the engines can be started and the models launched.
- (9) During the race you may leave the start position to rescue the model or to fetch spare materials. However while driving the competitor must not leave the start position. It is not allowed to remove the transmitter from the start position.
- (10) All buoys must be negotiated in accordance with the course. Touching the buoys is allowed. Only those laps negotiated in accordance with the course are counted.
- (11) During the race each competitors laps must be displayed on a score board.
- (12) If a buoy is passed on the wrong side, it is allowed to re circle the buoy without interfering with other competitors. If you do not re circle the buoy the lap will not be counted.

- (13) A slower boat can be overtaken on either side. During the overtaking manoeuvre the slower boat must not change course or get in the way of the overtaking boat. The overtaking boat can return to the racing line when no less than three boat lengths ahead.
- (14) The faster boat is not allowed to interfere with the slower model during the overtaking manoeuvre.
- (15) The boat on the race line which is less than 5 boat lengths from a buoy has right of way. A manoeuvre to force a boat to pass on the inside of a buoy in order to overtake is not permitted.
- (16) If during a race a boat stops, it can be retrieved by the rescue boat, causing minimum disruption to the other boats. The lap on which the boat stopped is not counted.
- (17) Boats returned by the rescue boat must resume the course from the starting position. After the new start the laps will be added to those previously achieved.
- (18) FSR-V boats can be repaired and refuelled during a heat. Only laps completed during the heat will be counted.
- (19) If a boat loses the number plate during the race it is allowed to complete the commenced lap. Any laps completed after this lap without a number plate will not be counted.
- (20) A race can be stopped by the start position official due to exceptional circumstances (e.g. sheered off buoys). Rules for stopping a race:
 - a) The start position official gives an acoustic signal the same as at the end of a race. At the same time as the signal is given the clock which measures the duration of the race is stopped. After the start position official has given the signal, the models have to complete the commenced lap.
 - b) The time, from when the signal was given, until the models pass the finish line, must be recorded. The models have to be taken from the water and the engines stopped.
 - c) Competitors and assistants have to step back from the models. Repairs are not permitted. During the interruption in the race models can be rescued.
 - d) After resolving the cause for the interruption, the start position official will give a start signal following the same procedure as at the beginning of the race. The time keeping will continue with the start signal.
 - e) If the race is stopped within the first three minutes it will be annulled and restarted from the beginning.

- (21) If a heat had to be stopped, all the laps and times have to be added together.
- (22) In cases of unfair behaviour, interference with other competitors, not following the rules, endangering spectators or rescue boat crew (e.g. collision with the starting pontoon) the start position leader can pronounce the following penalties.
- a) The first occurrence of not following the rules described in paragraphs (12) - (15), where no other boat has stopped as a result of the incident a warning (yellow card) will be given.
 - b) The second occurrence of not following the rules described in paragraphs (12) - (15), or a more serious incident, or running over a stopped boat will be punished with a one lap deduction (yellow card with number 1).
 - c) The third occurrence of not following the rules described in paragraphs (12) - (15), or exceptionally serious incident, or causing another boat to stop will be punished by a two lap deduction (yellow card with the number 2).
 - d) The fourth occurrence of not following the rules described in paragraphs (12) - (15), or exceptionally inconsiderate behaviour of a competitor will be punished by disqualification (red card). The model has to be taken out of the water immediately.
 - e) If a model touches a rescue boat the competitor is disqualified from that heat. The model has to be taken out of the water immediately.
 - f) If other models are involved in endangering, touching or collision with rescue boat, the start position official can in their own discretion penalise the other competitors as well.

The competitor must be verbally and visually notified of a penalty. *There is no possibility of an appeal against the decision.* The start position official must record the penalty and the start number of the competitor.

- (23) The end of the race is indicated by an acoustic signal. All models must after the signal complete the commenced lap and this lap will be counted. After the final signal the lap counters will record the time of delay for every model passing the finishing line. This time will be recorded with the number of laps.

6.6 Lap Counting for FSR-V races

Lap counting can be manual or computerised.

6.6.1 Manual lap counting

- (1) *With manual lap counting referees for counting will be provided by the organiser. The referees (judges) are responsible for the careful and proper lap counting.*

If difference of opinion exists amongst the lap counter referees, the decision lies with the start position official.

- (2) *The announcers and operators (counters) are working in pairs. They will supervise the counting of the models. The announcers will call at the passage of the finish line the respective start position number which will be registered by the operator (counter)*
- (3) *The lap counters must be seated on the left side from the pontoon(see 6.6.2.point 4)*

6.6.2 Computerised lap counting

- (1) For computerised lap counting only 4 to 6 lap counters are needed (2-3 announcers, 2-3 operators of the counting equipment).
- (2) The announcers and operators work in pairs and will be responsible for counting the models. The announcers will call the number of the model passing the finishing line and the lap will be recorded by the counting equipment operator.
- (3) Lap counters will only do the lap counting. Any lap deductions will be recorded by the assistant pontoon judges and will be deducted from the total of laps recorded by the lap counters at the end of the heat.
- (4) There is only one finish line for all 12/13 models. The finish line is located on the left hand side of start position 13 from the pontoon. The lap counters will be located in a raised position in line with the finish line.
- (5) In the event of equal number of laps, the competitor whose model passes the finish line first, will be the winner. *A competitor with a start position number higher than 1 can only be a winner, if they have overtaken all models in start numbers lower than them.*

6.7 Scoring in FSR-V classes

- (1) The competition result is decided on the number of valid laps and the delay time after deduction of penalty laps .
- (2) If there are 13 or less competitors entered for a particular class only two heats have to be run. The best score from the two heats will count to decide the places.
- (3) The places will be decided on the number of laps achieved. When there is more than one competitor with the same number of laps, the competitor with the shorter delay time will be placed higher.

- (4) In the event that a final race takes place in accordance with paragraph 6.5 item (3), the placing are as follows:
- The finalists are placed according to their finishing position in the final.
 - Placing of the remaining competitors will be in sequential order of the number of laps and delay time achieved in their best qualifying heat.

6.8 Composition of Result Lists in the FSR-V classes

The following items should be recorded in the result list of a competition in the FSR-V class:

- Type, place and date of the event
- Sequence of placing in accordance with paragraph 6.7
- Class
- Surname, Christian name and country registration number of the competitor
- Noise level result
- Number of valid laps (in brackets any laps deducted) from the best heat
- The delay time from the best heat
- Name and registration number of the judge
- Signatures of the chief judge

6.9 Competition course and duration of a race in the FSR-H classes

- (1) The competition will be held on a course as shown in drawing 4. The competition course has to be placed so that the base line runs parallel to the starting pontoon and the centre line is at a right angle from between start positions 4 and 5 to the centre buoy.

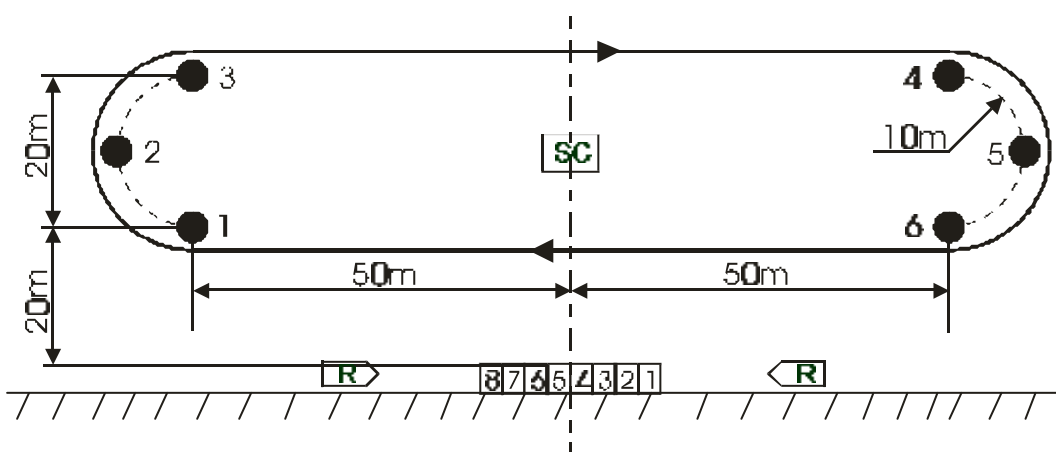

- = Start and finish line
- 8.....1 = Start positions
- RB = Rescue boat
- SC = Start clock

Drawing 4: FSR - H competition course

(2) The models have to achieve the following number of laps within 4 minutes:

FSR-H3.5	=	5 laps
FSR-H7.5	=	6 laps
FSR-H15	=	7 laps

(3) Starting time for the heat has to be shown on a start clock (see drawing 5) or other adequate (optical or acoustic) means.

6.10 Start clock for FSR-H classes

(1) The start clock is designed for FSR-H races with special optical and acoustical information and signals which the competitors use to prepare for the start of the heat.

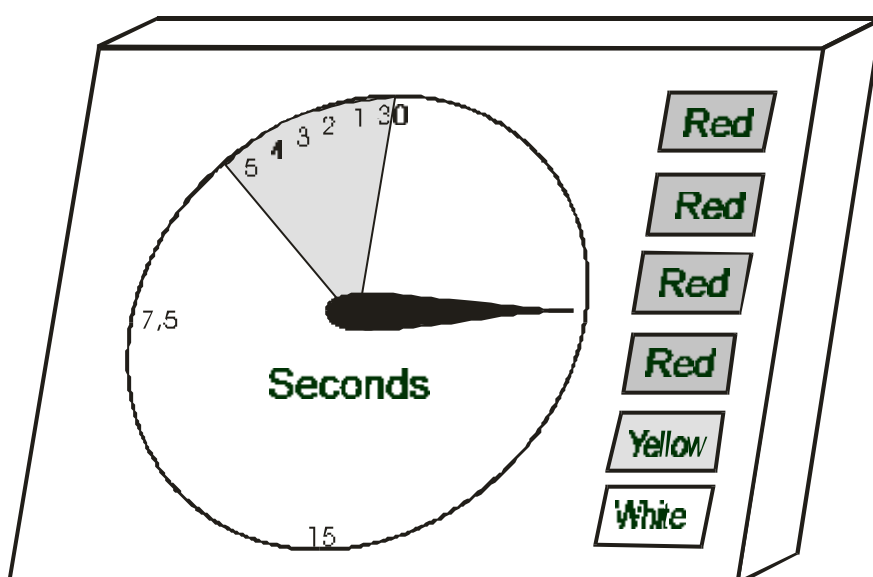

Drawing 5: Start clock for FSR-H races.

(2) The start clock must comply with the following:

- 1 turn of the hand must be 30 seconds with a precision of approx. 1 second.
- The face of the clock must show the following points: 15 seconds, 7.5 seconds, 5, 4, 3, 2, 1 seconds.
- The 5 second segment must be shown in a contrast colour.
- There must be 4 red lights which are all switched on at the beginning of preparation time. The lights will be switched off individually at 30 second intervals.
After the last red light has gone off a yellow light will come on which indicates the 30 seconds control time when no boats can be launched. At the end of this 30 seconds a white light or acoustic signal will indicate the start of the race.

- The clock hand must reach the “12 o’clock” position at exactly the same time as the light or acoustic signal indicate the start of the race.
- The face of the clock must be white or orange, the hand must be black.
- The diameter of the face of the clock must be between 750 and 1000 mm.
- The start clock must be able to float so that it can be positioned within the competition course.

6.11 Procedures for races in the FSR-H classes

- (1) A heat must have a minimum of 4 and maximum of 8 competitors. Each competitor must run at least 4 heats. If there are more than 8 competitors entered in a class, a final must be run in accordance with paragraph (2).
- (2) 8 competitors with the highest scores from the heats qualify for the final. For the final at least 4 heats must be run. The best placed competitor will occupy start position 5, the second best placed start position 4, the third best placed start position 6, the fourth best placed start position 3 etc. until the eight placed, who will occupy start position 1.
- (3) Before the start of each heat a radio check has to be carried out to prevent interference. Therefore all transmitters and receivers must be switched on. When it has been confirmed that there is no radio interference it is no longer possible to protest.
- (4) Each race consists of three independent phases:
 - Preparation time (Pit time) 2 minutes
 - Control time (Milling time) 30 seconds
 - Course time (Race time) 4 minutes
- (5) During preparation time engines are started, and the boats launched. If a competitor starts an engine after the preparation time, this race will not count. Races cannot be repeated. Preparation time must not be delayed or cancelled, unless in exceptional circumstances at the judges discretion (e.g. problems on the race course). Models can be adjusted during the preparation time, however the competitor is not allowed to leave the start position.
- (6) At the start of control time no further boats can be launched.
- (7) The competitors must drive their boats around the course *or the special lay-by zone allocated by the competition management*, so that all the competitors can cross the start line at the end of control time. Boats must drive the course in the clockwise direction.

- (8) During the last 15 seconds of the control time in order to ensure the safety of all the boats, the models must keep in a straight line after passing buoy No. 6. Zigzagging across the course, course changes in excess of 45 degrees in order to avoid crossing the start line early etc., are not allowed and are penalised with a one extra lap.
- (9) The end of the control time indicates the start of the race time, regardless of where the boats are on the course.
- (10) Models crossing the start line immediately before the end of control time have a false start and must therefore complete an extra lap.
- (11) The race officially starts, when at the end of control time the first boat crosses the starting line.
- (12) Missing a buoy and therefore cutting the course is penalised by one extra lap.
- (13) The competitor whose boat crosses the line first after completing the required number of laps and taking into account any penalties (additional laps) is the winner.
- (14) *In the event that no boat completes the required laps within the 4 minutes run time, the race is discounted. A repetition of the race is not permitted.*
- (15) Boats, which have not completed the required number of laps, receive 25 points.
- (16) After a competitor has completed the required number of laps they must remove the boat from the water. *The start position official can order such boats to quit the race course.*
- (17) If the start position official considers that there are boats on the race course which will not be able to complete the race in the time remaining, they can request them to take their boats out of the water. The point given will be the same as in cases when the race is not completed (25 points).
- (18) The race will only be re-run in cases of radio interference.
- (19) Heats must be organised so that no one competitor will have to take part in two consecutive races.
- (20) Each race must be run in accordance with the rules specified in section 6.12.

6.12 Basic rules and penalties in the FSR-H classes

Failing to comply with the following rules could result in a disqualification from one heat or the entire competition.

6.12.1 Left Turns

- (1) Excessive left turns on the course are not permitted, except when giving way or to avoid collision. Minor steering corrections to the left, or to overtake other boats are allowed.
- (2) Penalised by one extra lap will be in the following cases:
 - left turn in excess of 45 degrees.
 - when a competitor by turning to the left endangers another model
- (3) Causing damage to another boat, which will prevent it from being used in the competition will result in a disqualification from that heat.

6.12.2 Right of Way

- (1) *Reliable turning and steering techniques as well as sporting fairness are provisions for the proper sailing/use of the race course.*
- (2) The normal racing line is the line closest to the outline of the course. Boats on the racing line have right of way.
- (3) A boat on a normal racing line has the right to maintain its course.
- (4) A boat overtaking the boat ahead, which is on the same racing line must be at least 3 boat lengths ahead before it has the right of way.
- (5) Penalised by one extra lap will be in the following cases:
 - Not following the rules specifying the right of way
 - Preventing another boat from overtaking by a zigzagging, S - turns, etc.

6.12.3 Negotiating/passing the buoys

- (1) Each buoy on the race course must be negotiated on the outside. An exception can only be made by the start position official, if it would benefit the race situation or in order to avoid a collision.
- (2) Buoy penalties are given by the assistant pontoon judges. It is not possible to protest their decision.

(3) Penalised by one extra lap will be in the following cases:

- Passes a buoy on the inside (one penalty lap for each buoy)
- Driving inside the oval race course
- Cutting or crossing the race course
- Driving through the middle of the race course

(4) If a competitor cannot steer their boat properly they will received a warning. If their driving has not improved, they will be disqualified from this heat.

6.13 Rules for overtaking in the FSR-H classes

Overtaking in accordance with paragraph 6.12.2 is allowed on the entire course. The following examples are only guidance for the judges and cannot be cited by competitors in a possible protest. In the situations described below serious danger could arise to other boats or spectators. In this case the start position official can order the competitor, causing the danger, to discontinue the race. The competitor will be disqualified for this heat and will receive no points.

Example No. 1

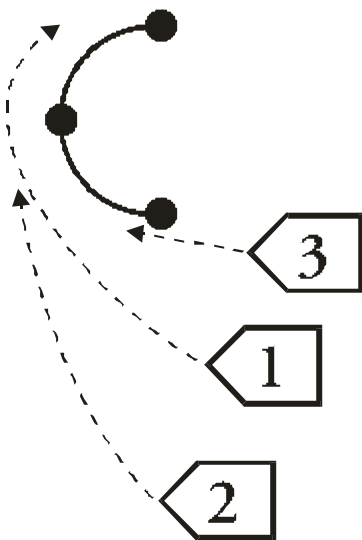

Boat No. 1 has the right of way, and boats No.2 and No.3 try to overtake.

Boat No.2 cuts the racing line for boat No.1, which results in a one extra lap Boat No. 3 tries to force its way on the inside, in order not to touch the buoy the boat No. 3 will have to turn left and will cut across boat No.1's racing line. This manoeuvre will result in one extra lap

Example No.2

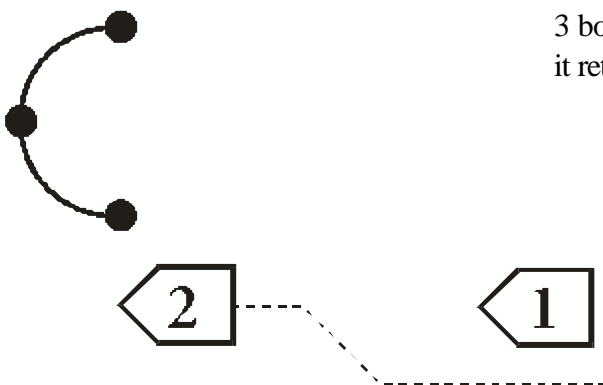

Boat No.2 overtakes correctly, it is at least 3 boat lengths ahead of boat No. 1 before it returns to the racing line.

Example No.3

Boat No.2 receives a one lap penalty because it forced boat No.1 to pass the buoy on the inside in order to avoid collision.

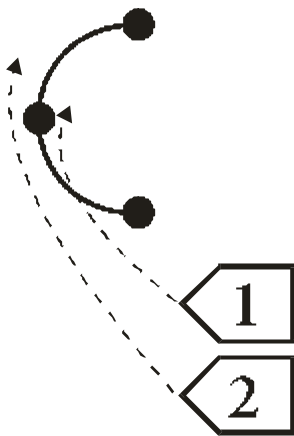

Example No.4

Boat No.2 correctly leaves the inside racing line clear.

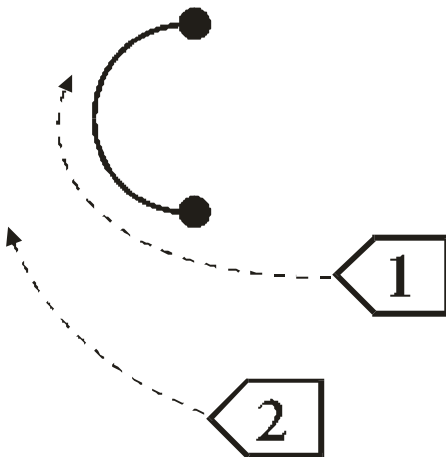

Example No.5

Boat No.1 leaves the inside racing line clear because it turned wide. It allows boat No.2 to overtake by making a tighter turn. In position X the boat No. 2 has the right of way.

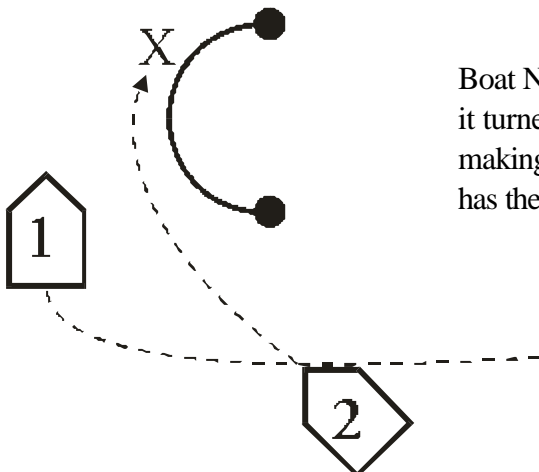

6.14 Calculation of final results in the FSR-H classes

- (1) In FSR - H classes, each competitor receives the following points according to the place achieved:

1. Place	=	400 points
2. Place	=	300 points
3. Place	=	225 points
4. Place	=	169 points
5. Place	=	127 points
6. Place	=	96 points
7. Place	=	72 points
8. Place	=	54 points
Race not completed	=	25 points
Boat did not pass the starting line after the starting signal	=	No points

- (1) In cases of equal points there should be a run off in the following cases:

- a) To select a competitor for the final.
- b) In the final, to decide places 1, 2 or 3

The run off will be held after the completion of the heats or after the finals.

- (2) The final result of the competition is the sum of all points achieved in all heats, unless finals are held.

- (3) If a final takes place, the results will be as follows:

- a) All the finalists are placed according to the total of points achieved during the final.
- b) The remaining competitors are placed according to the total of points achieved during the qualification heats.

6.15 Composition of result lists in the FSR-H classes

The following items should be recorded in the result list of a competition in the FSR-H class:

- Type, place and date of the event
- Class
- Surname, Christian name and country registration number of the competitor
- Noise level result
- Result of each race (points, penalty laps)
- Total points scored
- Total penalty laps
- Name and registration number of the judge

- Signature of the chief judge

7. Methods for measuring noise levels in the FSR category

7.1 General

- (1) The measurement microphone must be positioned as follows:
 - Height 1000 mm approx. X 200 mm above water level
 - Position 25 meters to the right for FSR-V and to the left for FSR-H at the right angle to the centreline of the FSR course and 22 meters away from the line connecting the two lowest buoys.
 - *The measurement microphone must be shown at right angles and with the connecting line of the two lowest buoys and securely attached.*
- (2) It is not necessary to pass the noise measuring equipment at full speed.
- (3) Faults with a silencer which cause excess noise level must be corrected immediately. The model must be taken off the water on completing the commenced lap, failing which the competitor will be disqualified.

7.2 Measuring methods in FSR-H classes

- (1) At least one noise measurement must be taken for each model during the race, under the following conditions:
 - There should be no other boat within 15 meters around the model being measured.
 - The noise measurement must be taken when the boat is on the base line at least 15 meters away from the microphone.
- (2) When more than one measurement is taken, the recorded noise level will be the average of all measurements.
- (3) The competitor must be advised immediately after the first race if their boat exceeds 80dB/A. If after the second race the boat still exceeds the noise level they will receive a warning and if during the third race the noise level is exceeded they will be immediately disqualified.

7.3 Measuring methods in FSR-V classes

- (1) At least three noise level measurements must be taken for each model during the race, under the following conditions:
 - There should be no other boat within 15 meters around the model being measured.
 - The noise measurement must be taken when the boat is on the base line at least 15 meters away from the microphone.
 - The measurements must be evenly spaced during the race.

- (2) The competitor must be advised immediately if their boat exceeds 80dB/A. If the second measurement also exceeds the noise level they will receive a warning and if the third measurement exceeds the noise level they will be immediately disqualified..

Appendix 1.

Guide to measurement/set up a FSR-V course

In order to set up an FSR - V course you need two fixed point 100m apart, 2 X 70 m strings and 2 X 122 m strings (points C-A-C, C-A1-C) and 2 X 78.1 m strings (C-B-C).

